

X030/301

NATIONAL
QUALIFICATIONS
2009

TUESDAY, 9 JUNE
1.00 PM – 4.00 PM

FABRICATION AND
WELDING
ENGINEERING
HIGHER

100 marks are allocated to this paper.

The paper is based on a case study.

For this examination candidates should have the following:

- (a) Worksheet for Q3(c)
- (b) Resource Pack including extracts from BSEN 1011
- (c) Drawing instruments.

Candidates should attempt **all** questions.

Marks for each question are shown in brackets after the question.

A candidate who uses a calculator in answering questions must ensure that the method employed and any intermediate steps in the calculation are sufficiently clear in the answer.



This paper consists of a case study with questions.

The case study is based on a sketch (Figure 1).

Attempt ALL questions, using the information provided in the Resource Pack where appropriate.

CASE STUDY

Figure 1, on *Page four*, illustrates details of a fabricated and welded Pressure Vessel End with a 12 mm thick “set-on” Pipe. The Pressure Vessel End has to be manufactured from 12 mm thick carbon steel with a composition as shown in the table below.

Material Composition:

Carbon (C) %	Silicon (Si) %	Manganese (Mn) %	Nickel (Ni) %	Chromium (Cr) %	Molybdenum (Mo) %	Copper (Cu) %	Remainder Iron with acceptable limits of impurities
0.15	0.10	1.50	0.10	0.40	0.40	0.10	

The welds for the manufacture of the component are to be produced in the flat position using the Metal Active Gas Welding Process (MAG), solid wire.

Marks

1. In the Metal Active Gas (MAG) welding process:

(a) explain how the shielding gas protects the weld pool from contamination;

2

(b) name the output characteristic for the type of power source used;

1

(c) state how the current is controlled;

2

(d) state the function of the following items of MAG welding equipment:

(i) Contact tip;

1

(ii) Wire Drive Unit;

3

(iii) Harness.

4

(13)

2. Interpret the **two** weld symbols as shown in Figure 1.

(4)

3. (a) Using the information detailed in the material composition table, calculate the Carbon Equivalent of the material used for the manufacture of the Pressure Vessel End. 5
- (b) Determine the pre-heat temperature for the weld shown between the Pipe and the Pressure Vessel End in Figure 1. 7
- Note:** Assume a heat input of 1·1 kJ/mm.
- (c) A partially completed Welding Procedure Specification is provided in **Worksheet Q3(c)**. Complete this specification for the weld shown between the Pipe and the Pressure Vessel End in Figure 1 by inserting the correct information in the boxes marked with an asterisk (*). 17
(29)
4. Produce a planning operations sheet for the manufacture of the Pressure Vessel End. The operations sheet should include information on each of the following:
- appropriate sequence of operations 5
 - marking out 4
 - cutting and forming processes 6
 - joining and assembly processes 6
 - inspection. 8
- The operations sheet should be appropriately designed. 5
(34)
5. (a) During service the Pressure Vessel End is subjected to tensile stresses. Explain the meaning of this term. 2
- (b) After manufacture the Pressure Vessel End has to be normalised. Describe how this process would be carried out. 4
(6)
6. During service the external shell of the Pressure Vessel is exposed to corrosive conditions and requires surface protection.
- (a) State **two** methods of preparing the component for surface protection. 2
- (b) State **two** suitable methods of surface protection. 2
(4)
7. Magnetic Particle Inspection (MPI) is used to test for cracking in the welds. Describe the procedure for carrying out this process. (10)

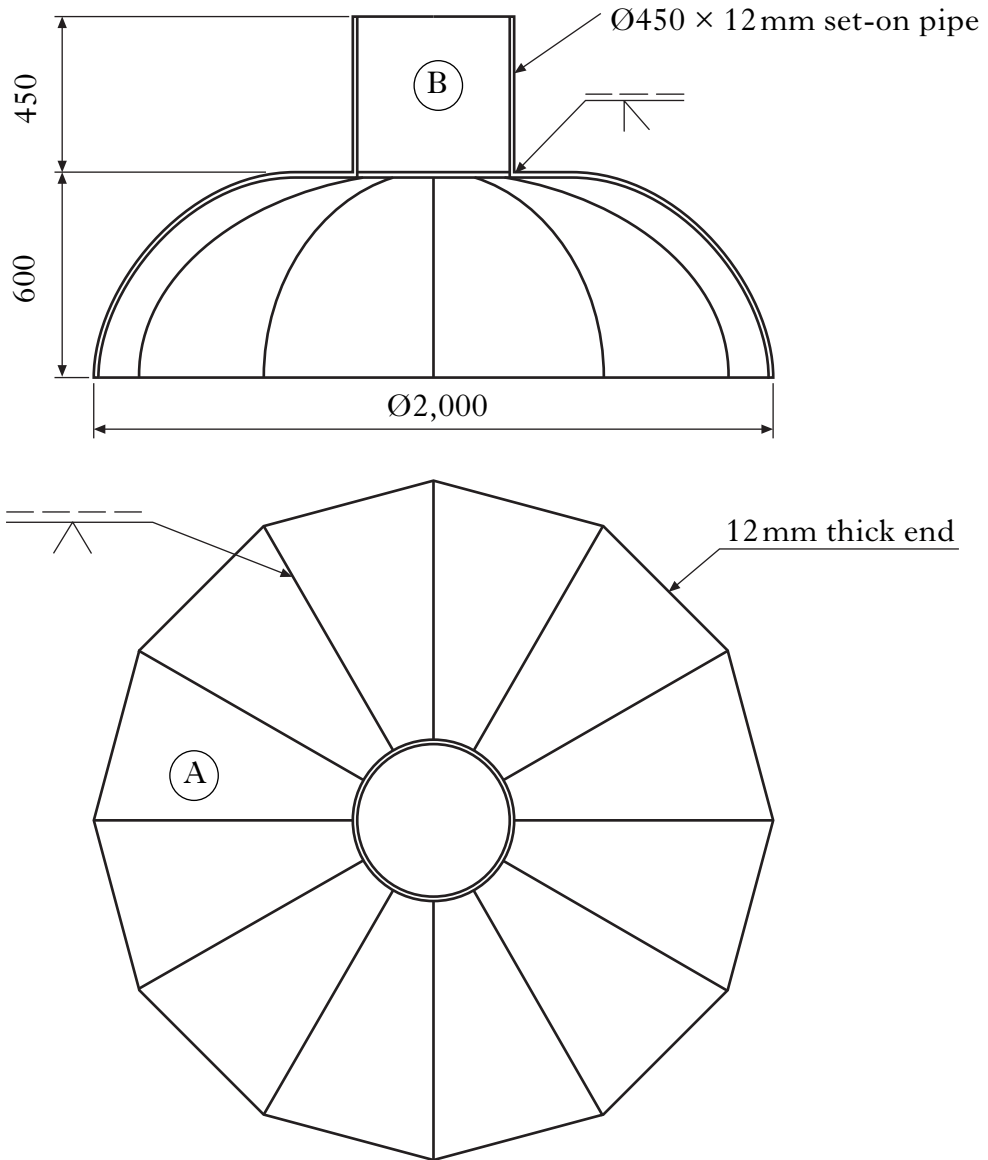

B	Pipe	1
A	Petal plate	12
PART	DESCRIPTION	No REQUIRED

FIGURE 1

Pressure Vessel End
(All dimensions in mm)

[END OF QUESTION PAPER]

[OPEN OUT]

[BLANK PAGE]

FOR OFFICIAL USE

--	--	--	--	--	--

Mark

--

X030/302

NATIONAL
QUALIFICATIONS
2009

TUESDAY, 9 JUNE
1.00 PM – 4.00 PM

FABRICATION AND
WELDING
ENGINEERING
HIGHER
Worksheet for Question 3(c)

Fill in these boxes and read what is printed below.

Full name of centre

--

Town

--

Forename(s)

--

Surname

--

Date of birth

Day Month Year

--	--	--	--	--	--	--	--

Scottish candidate number

--	--	--	--	--	--	--	--	--	--

Number of seat

--

To be inserted inside the front cover of the candidate's answer book and returned with it.



**WELDING PROCEDURE
QUALIFICATION RECORD (PQR)**

Qualification: Code/Standards
FOR EDUCATIONAL PURPOSES ONLY

Date of issue	01-06-2009
LR Office	Glasgow-North
PQR Certificate number	01-06-09-01

PWPS No. PQ-01-06-2009	Rev.	Date of welding 01-06-2009	Manufacturer's name and address Grangemouth Welding	
Test place/location shop/site Workshop				
RANGE OF APPROVAL				
Welding process(es) MAG	Single pass/multipass *		Test joint details (sketch with dimensions) of weld preparation *	
Joint types(s) *	Parent metal group(s) Group 1			
Plate thickness range 6mm - 24mm	Pipe outside diameter range 150 >			
Filler metal type/designation Murex LWI	Heat treatment Normalise			
Gas/flux *	Type of welding current *			
Welding positions flat/HV	Progression (up/down) N/A			
WELD AND FILLER METAL DETAILS				
Parent materials Carbon Steel	Test piece positions HV			Bead sequence detail (sketch to include weld metal thickness and back gouging where applicable) *
Welding process MAG	Joint type *			
Filler material Bostrand LWI	Shielding gas/flux flow rate 16l/min			
Make/Type/Diameter Murex	Gas composition *			
Composition EN 440-G42 3 M G3Sii	Flux type N/A			
Other information None				
Preheat and interpass temperature (method) and control *				
Postweld heat treatment temperature (method) and control Normalise in Furnace				

PROCEDURE DETAIL							
RUN NUMBER	PROCESS	SIZE OF FILLER MATERIAL	CURRENT A	VOLTAGE V	AC/DC POLARITY	WIRE FEED/TRAVEL SPEED	HEAT INPUT kJ/mm
1	MAG	*	190	22	*	4mm/sec	1.1
others	MAG	*	190	22	*	4mm/sec	1.1
Date	01-06-2009	Welder's name	William Campbell	WPQ Certificate No.	01-06-09-WPQ1		

[END OF WORKSHEET]

X030/303

NATIONAL
QUALIFICATIONS
2009

TUESDAY, 9 JUNE
1.00 PM – 4.00 PM

FABRICATION AND
WELDING
ENGINEERING
HIGHER
Resource Pack

This Resource Pack contains extracts from BSEN 1011.

Note that the original page numbers have been changed.



Introduction

The European Standard is being issued in several parts in order that it may be extended to cover the different types of metallic materials which will be produced to all European Standards for weldable metallic materials.

When this standard is referenced by contractual purposes the ordering authority or contracting parties should state the need for compliance with the relevant parts of this standard and such other annexes as are appropriate.

This standard gives general guidance for the satisfactory production and control of welding and details some of the possible detrimental phenomena which may occur, with advice on methods by which they may be avoided. It is generally applicable to fusion welding of metallic materials and is appropriate regardless of the type of fabrication involved, although the relevant application standard or the contract may have additional requirements. More information is contained in other parts of this standard. Permissible design stresses in welds, methods of testing and acceptance levels are not included because they depend on the service conditions of the fabrication. These details should be obtained from the relevant application standard or by agreement between the contracting parties.

It has been assumed in the drafting of this standard that the execution of its provisions is entrusted to appropriately qualified, trained and experienced personnel.

1. Scope

This European Standard gives general guidance for fusion welding of metallic materials in all forms of product (eg cast, wrought, extruded, forged).

The processes and techniques referred to in this part of EN 1011 may not all be applicable to all materials. Additional information relevant to specific materials is given in the relevant parts of the standard.

2. Normative references

This European Standard incorporates by dated or undated reference, provisions from other publications. These normative references are cited at the appropriate places in the text and the publications are listed hereafter. For dated references, subsequent amendments to or revisions of any of these publications apply to this European Standard only when incorporated in it by amendment or revision. For undated references the latest edition of the publication referred to applies.

EN 287–1, *Approval testing of welders—Fusion welding—Part 1: Steels.*

EN 287–2, *Approval testing of welders—Fusion welding—Part 2: Aluminium and aluminium alloys.*

prEN ISO 9606–3, *Approval testing of welders—Fusion welding—Part 3: Copper and copper alloys.*

prEN ISO 9606–4, *Approval testing of welders—Fusion welding—Part 4: Nickel and nickel alloys.*

prEN ISO 9606–5, *Approval testing of welders—Fusion welding—Part 5: Titanium and titanium alloys, zirconium and zirconium alloys.*

EN 288–2, *Specification and approval of welding procedures for metallic materials—Part 2: Welding procedure specification for arc welding.*

EN 439, *Welding consumables—Shielding gases for arc welding and cutting.*

EN 729–1, *Quality requirements for welding—Fusion welding of metallic materials—Part 1: Guidelines for selection and use.*

EN 729–2, *Quality requirements for welding—Fusion welding of metallic materials—Part 2: Comprehensive quality requirements.*

EN 729–3, *Quality requirements for welding—Fusion welding of metallic materials—Part 3: Standard quality requirements.*

EN 729–4, *Quality requirements for welding—Fusion welding of metallic materials—Part 4: Elementary quality requirements.*

EN 1418, *Welding personnel—Approval testing of welding operators for fusion welding and resistance weld setters for fully mechanized and automatic welding of metallic materials.*

EN ISO 13916, *Welding—Guidance for the measurement of preheating temperature, interpass temperature and preheat maintenance temperature during welding.* (ISO 13916:1996)

EN 22553, *Welded, brazed and soldered joints—Symbolic representation on drawings.* (ISO 22553:1992)

EN 24063, *Welding, brazing, soldering and braze welding of metals—Nomenclature of processes and reference numbers for symbolic representation on drawings.* (ISO 4063:1990)

3. Definitions

For the purposes of this standard the following definitions apply.

3.1

arc welding current I

current passing through the electrode

3.2

arc voltage U

electrical potential between contact tip or electrode holder and workpiece

3.3

interpass temperature T_i

temperature in a multi-run weld and adjacent parent metal immediately prior to the application of the next run

3.4

heat input Q

energy introduced into the weld region during welding per unit run length

3.5

preheat temperature T_p

temperature of the workpiece in the weld zone immediately prior to any welding operation

3.6

thermal efficiency k

ratio of heat energy introduced into the weld to the electrical energy consumed by the arc

3.7

welding speed v

travel speed of the weld pool

3.8

detrimental effect

imperfections and other harmful influences in the welded area

3.9**run-on plate**

piece of metal so placed as to enable the full section of weld metal to be obtained at the beginning of a joint

3.10**run-off plate**

piece of metal so placed as to enable the full section of weld metal to be maintained up to the end of a joint

3.11**wire feed rate w_f :**

length of wire consumed per unit time

3.12**contract**

a contract is:

–either the agreed requirements for constructions ordered by a customer;

–or the manufacturer's basic specification for constructions manufactured in series for several customers, unknown to the manufacturer at the time of design and production

The contract is, in both cases, assumed to include reference to all relevant regulatory requirements.

NOTE The role of the independent body is considered to be a matter which is determined by the contracting parties and/or the application standard.

3.13**welding consumables**

materials consumed in the making of a weld, including filler metals, fluxes and gases

4. Abbreviations and symbols

Abbreviations and symbols	Term	Unit
I	Arc welding current	A
k	Thermal efficiency factor	—
l	Length of a run	mm
Q	Heat input	kJ/mm
d	Material thickness	mm
T_i	Interpass temperature	°C
T_p	Preheat temperature	°C
U	Arc voltage	V
v	Welding speed	mm/s
w_f	Wire feed rate	mm/min or m/min
WPS	Welding procedure specification	—

5. Provision of quality requirements

The contract shall give the information necessary for the execution of the welding. If the manufacturer is recommended to have a quality system, the information should be in accordance with the appropriate part of EN 729 (see annex A for further information).

6. Storage and handling of parent materials

Storage and handling shall be carried out so that the parent material is not adversely affected.

7. Fusion welding processes

The standard covers welds made by one of the following welding processes in accordance with EN 24063 or by a combination of those processes:

- 111 manual metal-arc welding with covered electrode;
- 114 flux-cored wire metal-arc welding without gas shield;
- 12 submerged arc welding;
- 131 metal-arc inert gas welding; MIG welding;
- 135 metal-arc active gas welding; MAG welding;
- 136 flux-cored wire metal-arc welding with active gas shield;
- 137 flux-cored wire metal-arc welding with inert gas shield;
- 138 metal-cored wire metal-arc welding with active gas shield;
- 139 metal-cored wire metal-arc welding with inert gas shield;
- 141 tungsten inert gas arc welding; TIG welding;
- 15 plasma arc welding
- other fusion welding processes by agreement.

19. Heat input

The heat input during welding can be a main influencing factor on the properties of welds. It affects the temperature-time-cycles occurring during welding.

Where appropriate, the heat input value Q may be calculated as follows (see also Table 1):

$$Q = k \frac{U \times I}{v} \times 10^{-3} \quad \text{in kJ/mm}$$

Where the factor k differs from those shown in the Table 1, information will be given in the relevant parts of this standard.

20. Welding procedures

When written welding procedure specifications are required they shall cover all welding operations including temporary attachments and correction of non-conformities. The contents of the procedures shall comply with EN 288–2. Where applicable, the welding procedure approval shall be in accordance with the appropriate European Standard.

Welders/welding operators shall be provided with information to enable the welding procedure to be carried out in accordance with the requirements. Where appropriate, they shall be approved to the relevant part of EN 287, prEN ISO 9606 or EN 1418.

21. Traceability

When specified, adequate means of identification, either by an identification mark or other methods, shall be provided to enable each weld to be traced to the welder/welders or welding operator/operators by whom it was made. Hard stamping should be avoided, but when it has to be used attention is drawn to its use in highly stressed areas and areas susceptible to corrosion.

22. Peening

Peening of welds shall be carried out only in accordance with the application standard or the contract.

23. Inspection and testing

The method and extent of inspection and testing shall be in accordance with the application standard or the contract.

24. Quality requirements

Welded joints shall be free from unpermitted imperfections as they would impair the service performance of the structure. Acceptance levels shall be in accordance with the contract.

25. Correction of non-conformity

Where welds do not comply with the acceptance level of clause 24, remedial action approved by the contract and re-inspection shall be carried out to the original welding procedure or to an agreed procedure.

If undercut or other procedure defects are blended out by grinding or other mechanical methods, care shall be taken to ensure that the design thickness of parent material is not reduced.

In some circumstances, unacceptable undercut or large root gaps in fillet welds may be acceptable by the deposition of additional weld metal in accordance with the relevant parts of this standard.

Incorrectly fitted parts may be cut apart and rewelded in accordance with this standard and the application standard where it exists.

26. Distortion

Parts distorted by welding, beyond the specified tolerances, may be corrected only by a method agreed between the contracting parties or given in the contract. Any method to correct distortion should not be deleterious to the structure.

27. Post-weld heat treatment

When post-weld heat treatment and/or ageing is required, this shall be carried out in accordance with the contract.

The effects on the properties of the parent material, heat affected zone (HAZ) and weld metal shall be taken into account.

28. Post-weld cleaning

Post-weld cleaning, if necessary, shall be carried out in accordance with the contract.

The corrosion resistance is significantly affected by the surface quality. The method of post-weld cleaning depends upon the weld quality requirements.

Process No	Process	Factor <i>k</i>
121	Submerged arc welding with wire electrode	1,0
111	Metal-arc welding with covered electrode	0,8
131	MIG welding	0,8
135	MAG welding	0,8
114	Flux-cored wire metal-arc welding without gas shield	0,8
136	Flux-cored wire metal-arc welding with active gas shield	0,8
137	Flux-cored wire metal-arc welding with inert gas shield	0,8
138	Metal-cored wire metal-arc welding with active gas shield	0,8
139	Metal-cored wire metal-arc welding with inert gas shield	0,8
141	TIG welding	0,6
15	Plasma arc welding	0,6

Annex B (informative)

Guidance on joint detail design (when there is no application standard)

B.1 General

This annex may be used where no guidance from an application standard exists. Further information is given in other documents eg EN 1708-1:1999, EN 1708-2. Particular guidance on design to avoid lamellar tearing is given by annex F.

B.2 Butt joints

Butt joints between parts of unequal cross-section, arranged in line, will result in local increase in stress in addition to the stress concentration caused by the profile of the weld itself. If the centre planes of the two parts joined do not coincide, local bending also will be induced at the joint. If the stresses induced by these effects are unacceptable, then the parts should be shaped before welding by a slope of not greater than 1 in 4 so as to reduce the stresses. Examples of plain and shaped parts are shown in Figure B.1, where (a) and (b) are the more common types with (c) being a special configuration to facilitate non-destructive testing.

A partial penetration butt weld which is welded from one side only should be subjected to a bending moment about the longitudinal axis of a weld. It would cause the root of the weld to be in tension. Therefore it should be avoided and only used when permitted by the design. Under such circumstances it may be allowed by an application standard or contract.

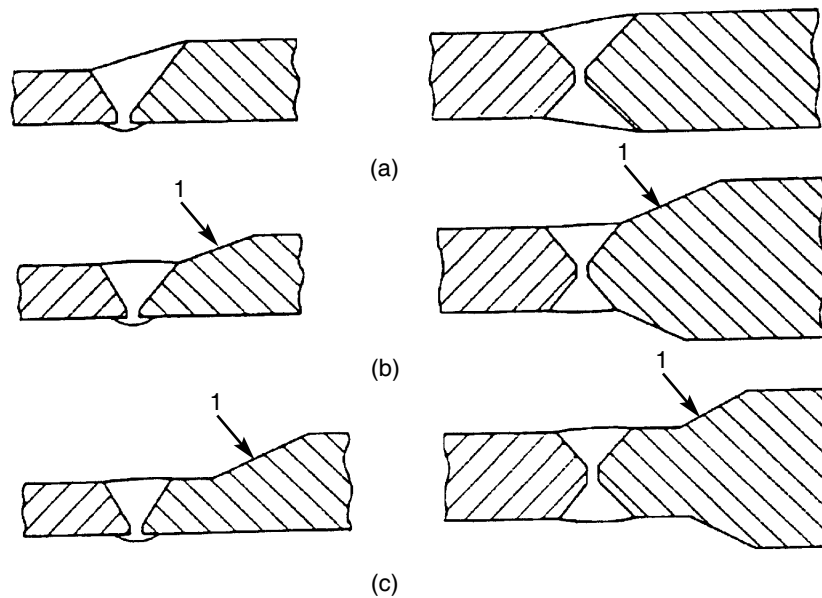

Key

- 1 Slope approximately 1 in 4
- (a) Slope in the weld
- (b) Slope in the thicker plate
- (c) Special configuration to facilitate non-destructive testing

Figure B.1—Butt joints of unequal cross-section

[Turn over

B.3 Fillet welds

The effective length of an open ended fillet weld should be taken as the overall length less twice the leg length. In any case, the effective length should be not less than 25 mm or four times the leg length whichever is the greater.

For fillet welded joints carrying a compressive load, it should not be assumed that the parts joined are in contact under the joint. For critical applications the use of a partial or even a full penetration butt weld should be considered.

Where the specified leg length of a fillet weld, at the edge of a plate or section, is such that the parent metal does not project beyond the weld, melting of the outer corner or corners, which reduces the throat thickness, is not allowed (see Figure B.2).

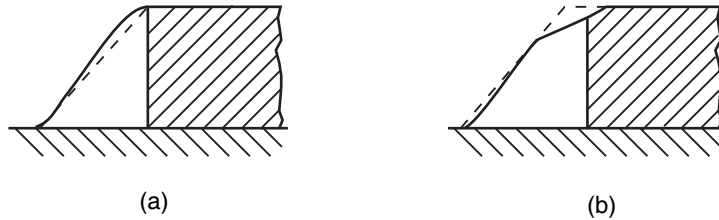

- (a) Desirable
- (b) Not acceptable because of reduced throat thickness

Figure B.2—Fillet welds applied to the edge of a part

A single fillet weld should not be subjected to a bending moment about the longitudinal axis of the joint which would cause the root of the weld to be in tension.

Fillet welds connecting parts, where the fusion faces form an angle of more than 120° or less than 60°, should not be relied upon to transmit calculated loads at the full working stresses unless permitted to do so by the application standard.

The design throat thickness of a flat or convex fillet weld connecting parts, where the fusion faces form an angle between 60° and 120°, can be derived by multiplying the leg length by the appropriate factor as given in Table B.1.

Table B.1—Factors for deriving design throat thickness of flat or convex fillet welds based on leg angle

Angle between fusion faces (degrees)	Factor
60 to 90	0.7
91 to 100	0.65
101 to 106	0.60
107 to 113	0.55
114 to 120	0.50

Due account should be taken of fabrication, transport, and erection stresses particularly for those fillet welds which have been designed to carry only a light load during service.

The determination of safe, but economic, preheating levels for the prevention of hydrogen cracking is critically dependent on an accurate knowledge of parent metal composition and carbon equivalent, *CE*, and on the weld metal composition (see C.2.9).

Carbon equivalent (*CE*) values for parent material are calculated using the following formula:

$$CE = C + \frac{Mn}{6} + \frac{Cr + Mo + V}{5} + \frac{Ni + Cu}{15} \text{ in } \% \quad (C.1)$$

Clause C.2 is applicable to steels with a carbon equivalent (*CE*) in the range 0,30 to 0,70.

If, of the elements in this formula only carbon and manganese are stated on the mill sheet for carbon and carbon manganese steels, then 0,03 should be added to the calculated value to allow for residual elements. Where steels of different carbon equivalent or grade are being joined, the higher carbon equivalent value should be used.

This carbon equivalent formula may not be suitable for boron-containing steels.

C.2.2 Factors affecting cracking

The occurrence of hydrogen cracking depends on a number of factors: composition of the steel, the welding procedure, welding consumables and the stress involved, if the $t_{8/5}$ time (cooling time from 800 °C to 500 °C) associated with welding is too short, excessive hardening can occur in the heat affected zone. When the hydrogen in the weld is above a critical level the hardened zone can crack spontaneously under the influence of residual stress after the weld has cooled to near ambient temperature. Welding conditions may be selected to avoid cracking by ensuring that the heat affected zone cools sufficiently slowly, by control of weld run dimensions in relation to metal thickness, and if necessary, by applying preheat and controlling interpass temperature. Procedures for avoiding hydrogen cracking, as well as selecting cooling times through the transformation temperature range to avoid hardened and susceptible microstructures, may involve controlling cooling in the lower temperature part of the thermal cycle, typically from 300 °C to 100 °C, thereby beneficially influencing the evolution of hydrogen from the welded joint. In particular, this can be achieved by the application of a post-heat on completion of welding which is typically a maintenance of the preheat temperature.

The hydrogen content of the weld can be controlled by using hydrogen controlled welding processes and consumables, and also to some extent, by the application of post-heat as described previously.

Similar considerations apply to hydrogen cracking in the weld metal, where although hardening will be on a reduced scale, actual hydrogen and stress levels are likely to be higher than in the heat affected zone. In general, welding procedures selected to avoid heat affected zone hydrogen cracking will also avoid cracking in the weld metal. However, under some conditions such as high restraint, low *CE* steels, thick sections, or alloyed weld metal, weld metal hydrogen cracking can become the dominant mechanism.

The most effective assurance of avoiding hydrogen cracking is to reduce the hydrogen input to the weld metal from the welding consumables. The benefits resulting from a growing number of possibilities where no preheat temperature > 20 °C is required, can (as shown by examples in Table C.1) be increased by using filler materials with lower hydrogen content.

Table C.1—Examples of maximum combined thickness (see C.2.4) weldable without preheat

Diffusible hydrogen content* ml/100 g of deposited metal	Maximum combined thickness			
	<i>CE</i> of 0,49		<i>CE</i> of 0,43	
	Heat input 1,0 kJ/mm	Heat input 2,0 kJ/mm	Heat input 1,0 kJ/mm	Heat input 2,0 kJ/mm
	mm	mm	mm	mm
> 15	25	50	40	80
10 ≤ 15	30	55	50	90
5 ≤ 10	35	65	60	100
3 ≤ 5	50	100	100	100
≤ 3	60	100	100	100

* Measured in accordance with ISO 3690

Welding conditions for avoiding hydrogen cracking in carbon manganese steels have been drawn up in graphical form in Figure C.2 for the normal range of compositions, expressed as carbon equivalent, covered by this standard and these conditions should be followed for all types of joint whenever practicable.

The conditions have been drawn up to take account of differences in behaviour between different steels of the same carbon equivalent (making allowances for scatter in hardness) and of normal variations between ladle and product analysis. They are valid for the avoidance of both heat affected zone and weld metal cracking in the majority of welding situations (see also C.2.9).

C.2.3 Hydrogen content of welding consumables**C.2.3.1 General**

The manufacturer should be able to demonstrate that he has used the consumables in the manner recommended by the consumable manufacturer and that the consumables have been stored and dried or baked to the appropriate temperature levels and times.

C.2.3.1 Hydrogen scales

The hydrogen scale to be used by any arc welding process depends principally on the weld diffusible hydrogen content and should be as given in Table C.2. The value used should be stated by the consumable manufacturer in accordance with the relevant standard where it exists (or as independently determined) in conjunction with a specified condition of supply and treatment.

Table C.2—Hydrogen scales

Diffusible hydrogen content* ml/100 g of deposited metal	Hydrogen scale
> 15	A
10 > 15	B
5 ≤ 10	C
3 ≤ 5	D
≤ 3	E

C.2.3.3 Selection of hydrogen scales

The following gives general guidance on the selection of the appropriate hydrogen scale for various welding processes.

Manual metal arc basic covered electrodes can be used with scales B to D depending on the electrode manufacturer's classification of the consumable. Manual arc metal rutile or cellulosic electrodes should be used with scale A.

Flux-cored or metal-cored consumables can be used with scales B to D depending on the manufacturer's classification of the wire. Submerged-arc wire and flux consumable combinations can have hydrogen levels corresponding to scales B to D, although most typically these will be scale C but therefore need assessing in the case of each named product combination and condition. Submerged-arc fluxes can be classified by the manufacturer but this does not necessarily confirm that a practical flux/wire combination also meets the same classification.

Solid wires for gas-shielded arc welding and for TIG welding may be used with scale D unless specifically assessed and shown to meet scale E. Scale E may also be found to be appropriate for some cored wires and some manual metal arc basic covered electrodes, but only after specific assessment. On achieving these low levels of hydrogen, consideration should be given to the contribution of hydrogen from the shielding gas composition and atmospheric humidity from welding.

For plasma arc welding, specific assessment should be made.

C.2.4 Combined thickness

Combined thickness should be determined as the sum of the parent metal thicknesses averaged over a distance of 75 mm from the weld line (see Figure C.1).

Combined thickness is used to assess the heat sink of a joint for the purpose of determining the cooling rate.

If the thickness increases greatly just beyond 75 mm from the weld line, it may be necessary to use a higher combined thickness value.

For the same metal thickness, the preheating temperature is higher in a fillet weld than in a butt weld because the combined thickness, and therefore the heat sink, is greater.

d_1 = average thickness over a length of 75 mm

Dimensions in millimetres

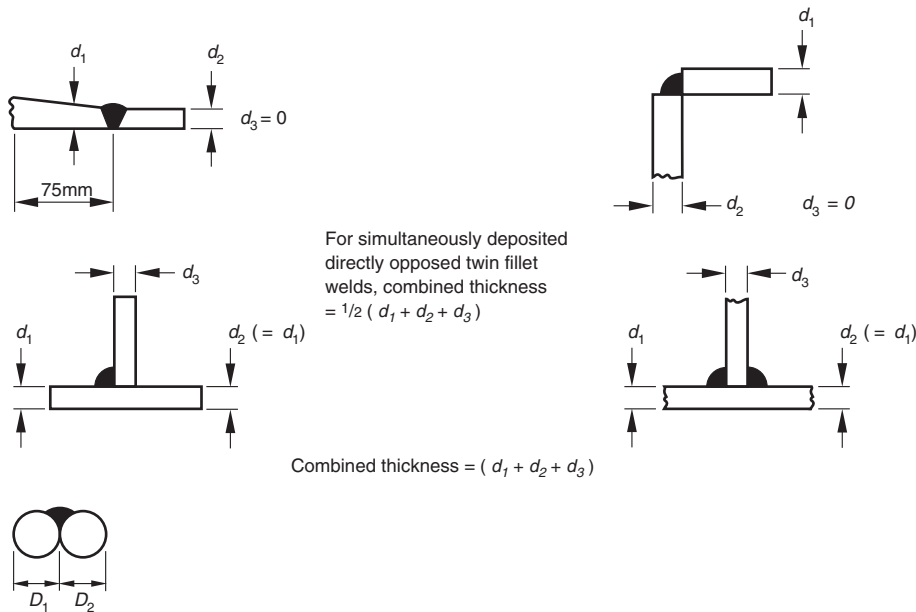

Combined thickness = $\frac{1}{2} (D_1 + D_2)$ Maximum diameter 40 mm

The limited heat sink has to be considered [see C.2.10(b)].

Figure C.1—Examples for the determination of combined thickness

C.2.5 Preheat temperature

The preheating temperature to be used should be obtained from Figure C.2 (a) to (m) by reading the preheat line immediately above or to the left of the co-ordinated point for heat input and combined thickness.

C.2.6 Interpass temperature

The minimum recommended interpass temperature is frequently used as the preheat temperature for multi-run welds. However, multi-run welds may have a lower permitted interpass temperature than the preheat temperature where subsequent runs are of higher heat input than the root run. In these cases the interpass temperature should be determined from Figure C.2 (a) to (m) for the larger run. Recommendations relating to maximum interpass temperature for creep resisting and low temperature steels are given in Table C.5 and Table C.6.

C.2.7 Heat input

Heat input values (in kJ/mm) for use with Figure C.2 should be calculated in accordance with EN 1011–1:1998 and clause 15.

[Turn over

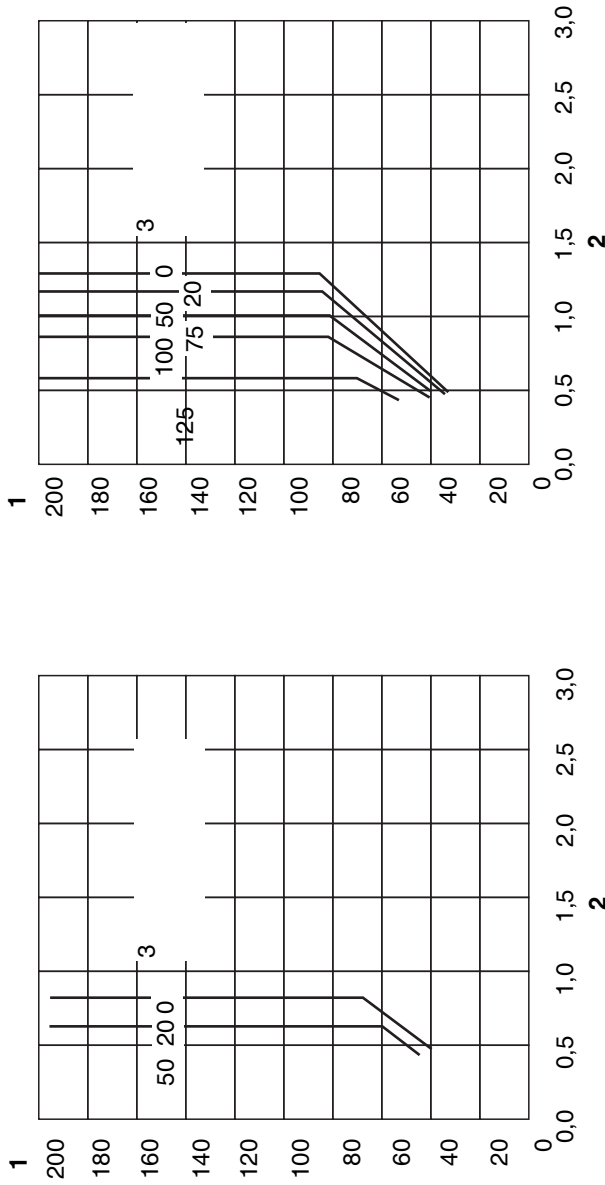

Figure C.2(a)

Figure C.2(b)

Key

- 1 Combined thickness, mm
- 2 Heat input, kJ/mm
- 3 Minimum preheating temperature, °C
- 4 Scale
- 5 To be used for carbon equivalent not exceeding

Figure C.2. Conditions for welding steels with defined carbon equivalents

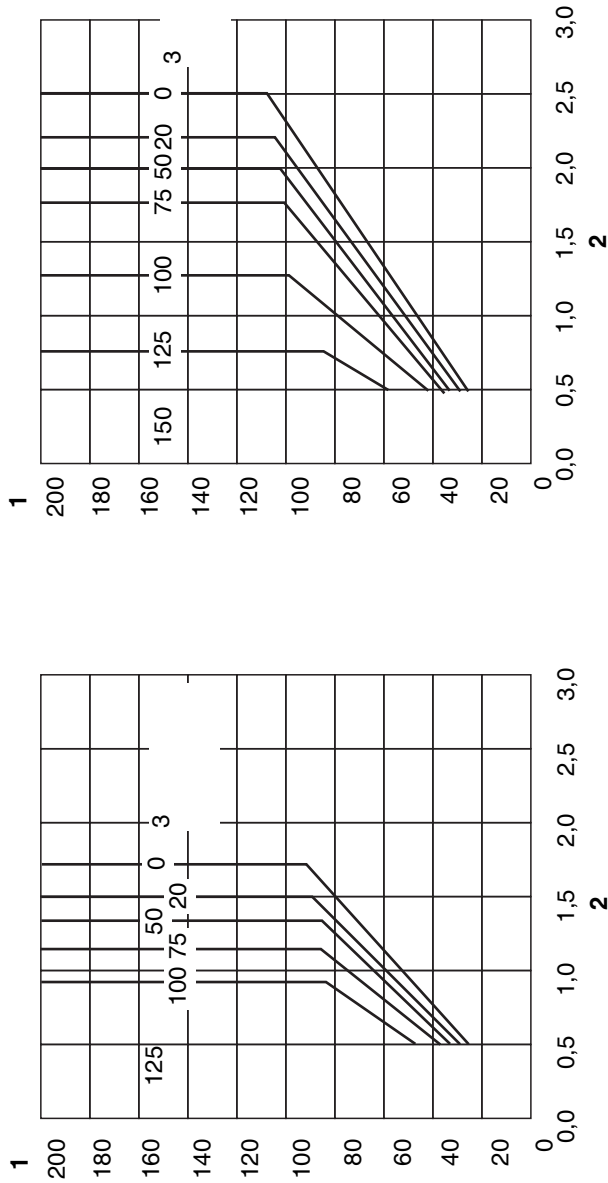

Figure C.2(d)

Figure C.2(c)

Key

- 1 Combined thickness, mm
- 2 Heat input, kJ/mm
- 3 Minimum preheating temperature, °C
- 4 Scale
- 5 To be used for carbon equivalent not exceeding

Figure C.2. Conditions for welding steels with defined carbon equivalents

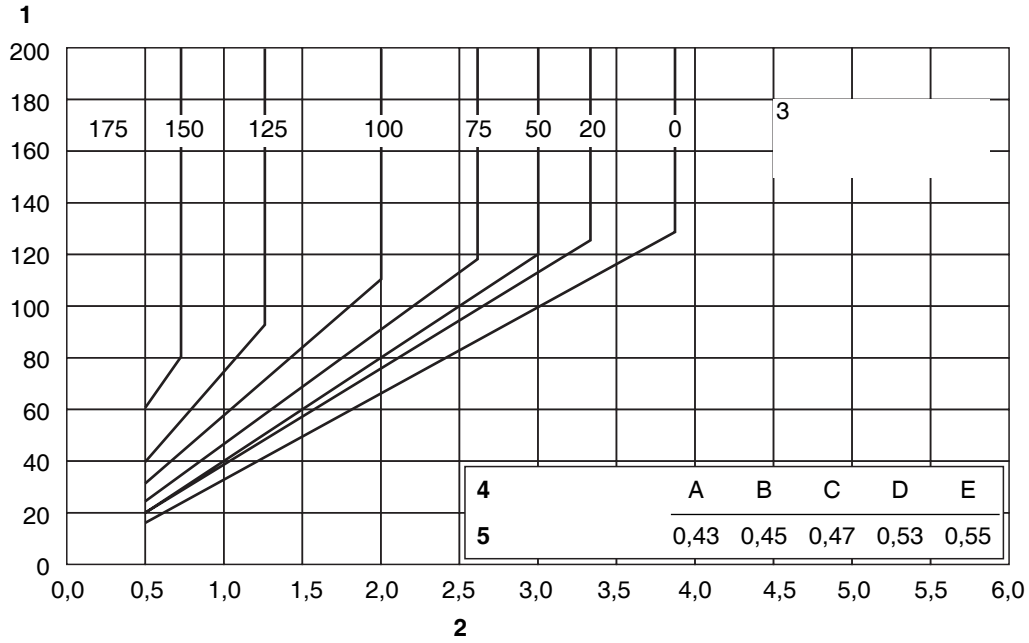

Figure C.2(e)

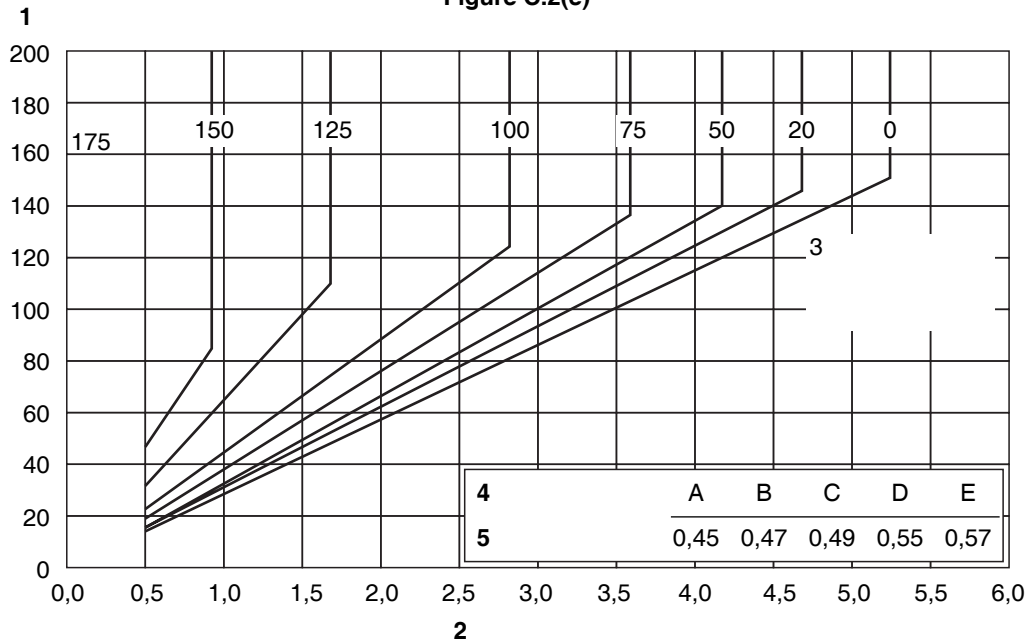

Figure C.2(f)

Key

- 1 Combined thickness, mm
- 2 Heat input, kJ/mm
- 3 Minimum preheating temperature, °C
- 4 Scale
- 5 To be used for carbon equivalent not exceeding

Figure C.2. Conditions for welding steels with defined carbon equivalents

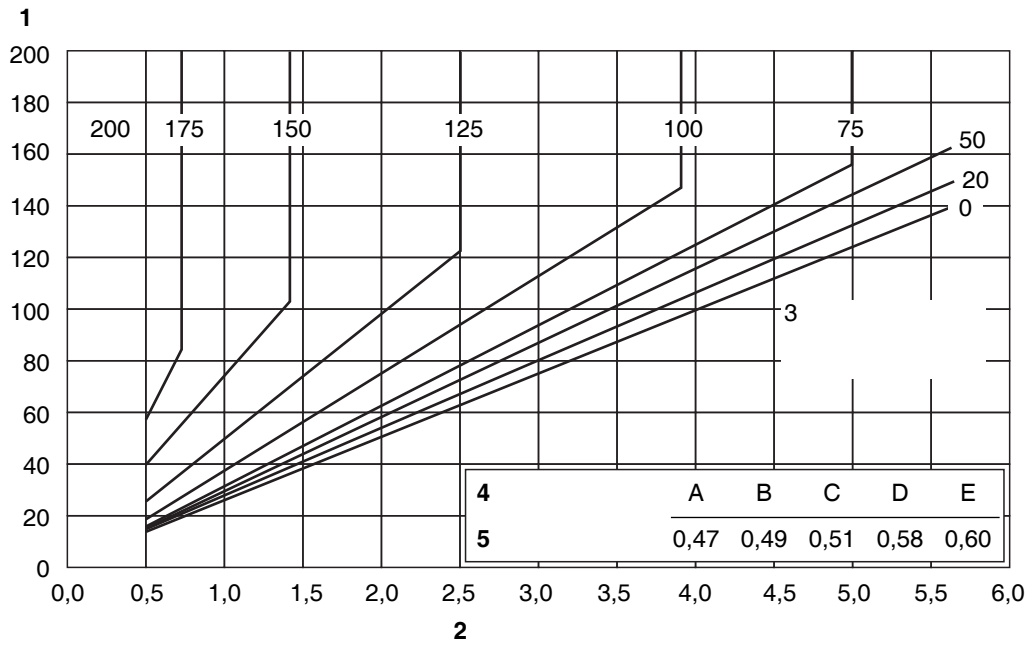

Figure C.2(g)

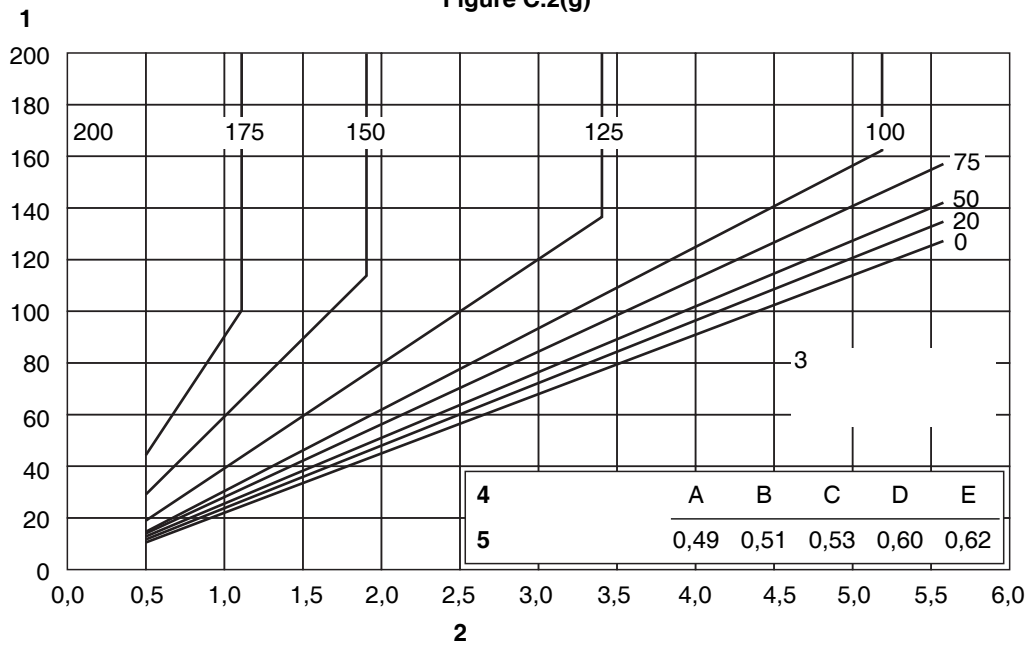

Figure C.2(h)

Key

- 1 Combined thickness, mm
- 2 Heat input, kJ/mm
- 3 Minimum preheating temperature, °C
- 4 Scale
- 5 To be used for carbon equivalent not exceeding

Figure C.2. Conditions for welding steels with defined carbon equivalents

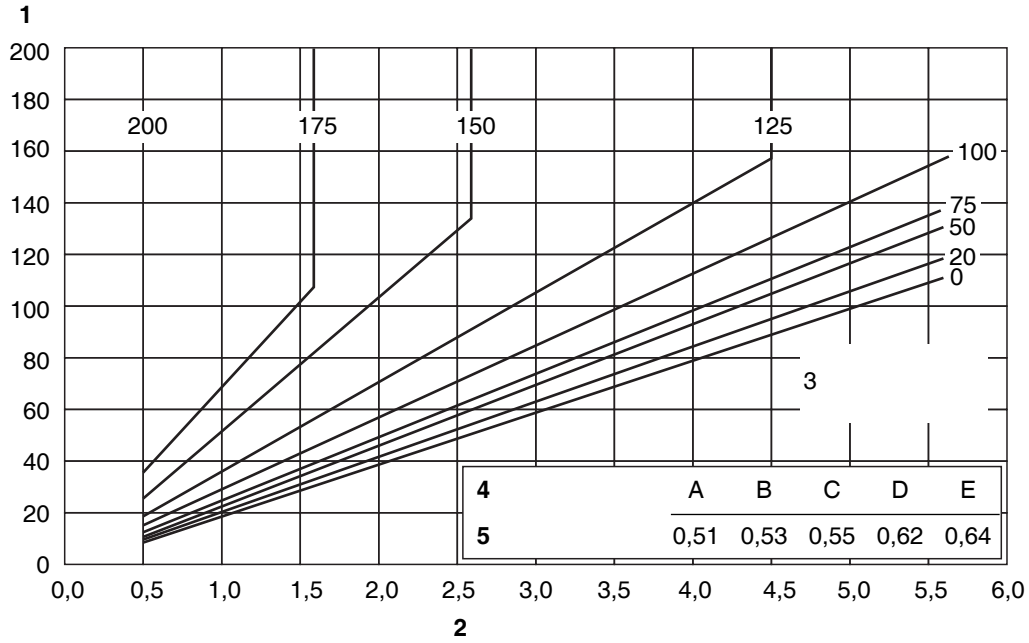

Figure C.2(i)

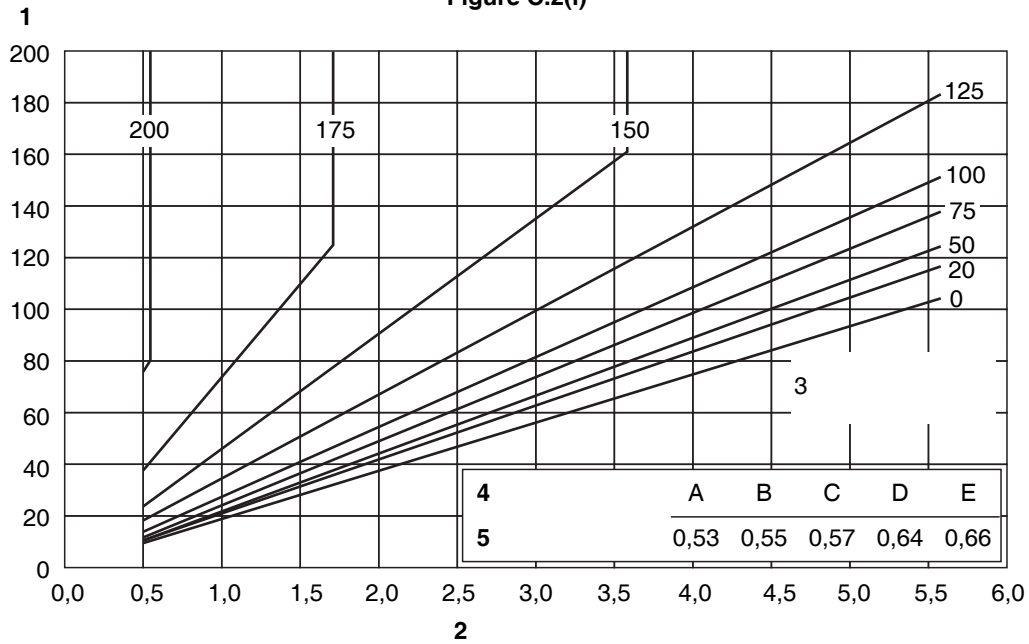

Figure C.2(j)

Key

- 1 Combined thickness, mm
- 2 Heat input, kJ/mm
- 3 Minimum preheating temperature, °C
- 4 Scale
- 5 To be used for carbon equivalent not exceeding

Figure C.2. Conditions for welding steels with defined carbon equivalents

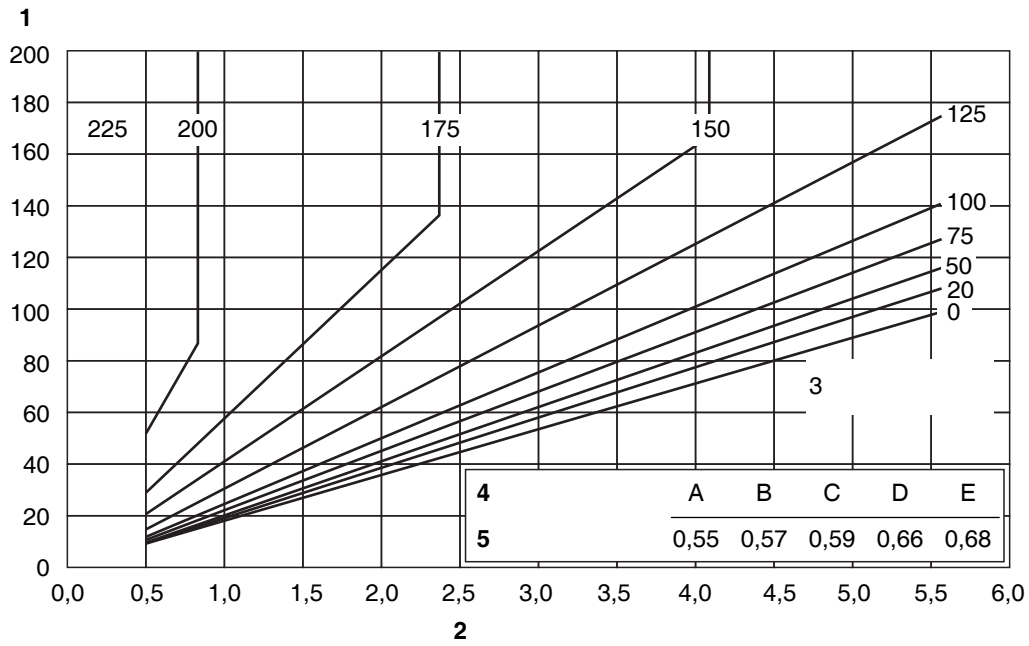

Figure C.2(k)

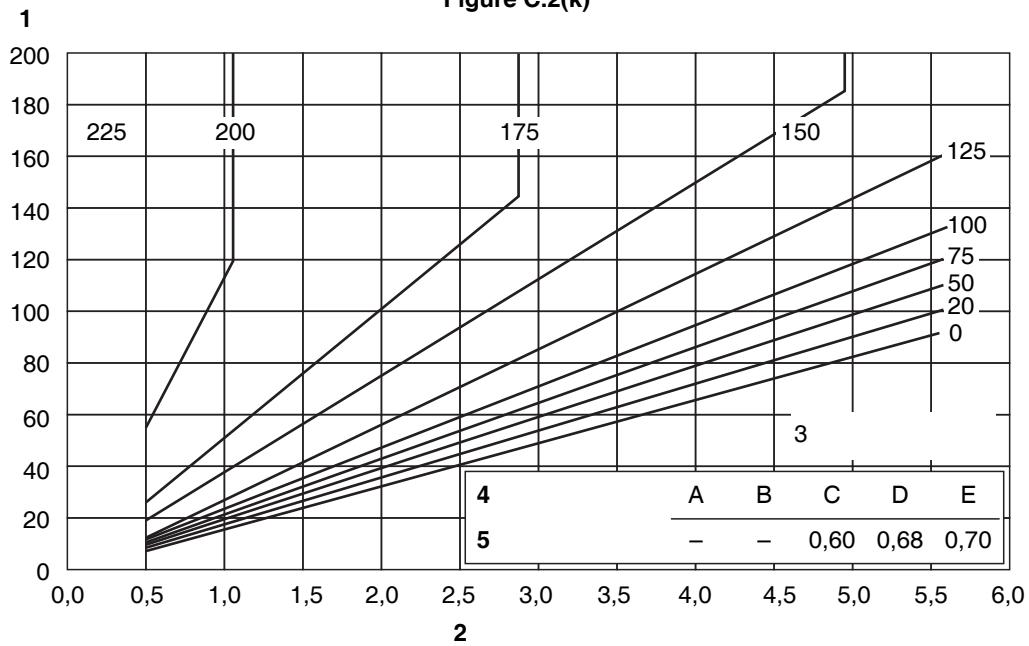
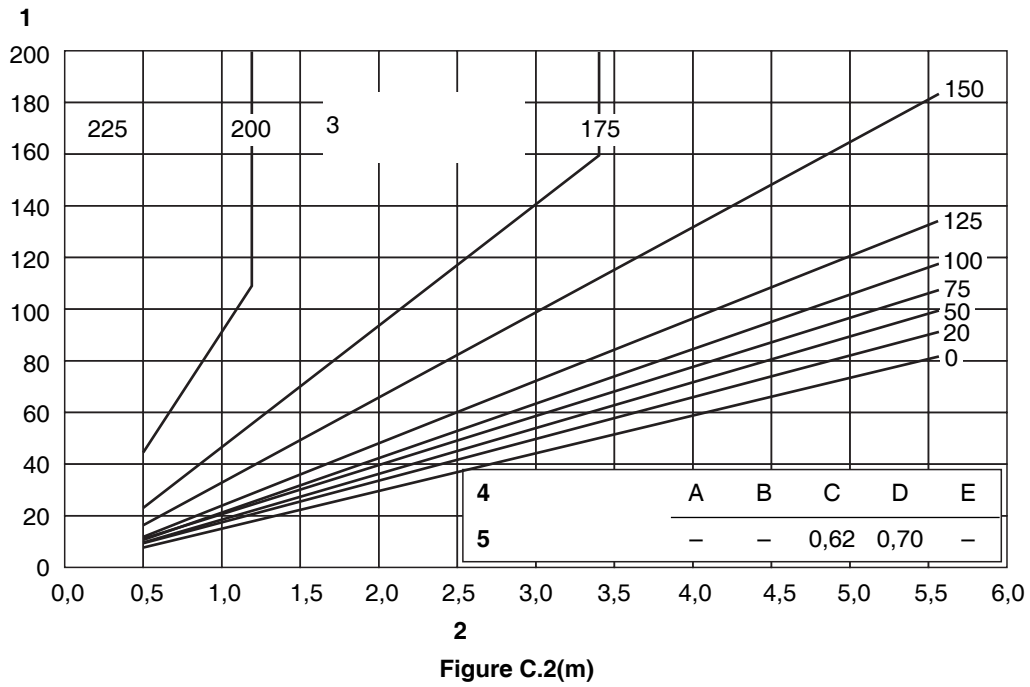

Figure C.2(l)

Key

- 1 Combined thickness, mm
- 2 Heat input, kJ/mm
- 3 Minimum preheating temperature, °C
- 4 Scale
- 5 To be used for carbon equivalent not exceeding

Figure C.2. Conditions for welding steels with defined carbon equivalents



Key

- 1 Combined thickness, mm
- 2 Heat input, kJ/mm
- 3 Minimum preheating temperature, °C
- 4 Scale
- 5 To be used for carbon equivalent not exceeding

Figure C.2. Conditions for welding steels with defined carbon equivalents

Table 15 Typical forms of butt weld preparation (other than structural hollow sections)

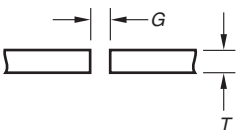
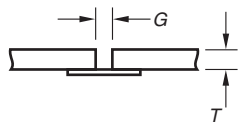
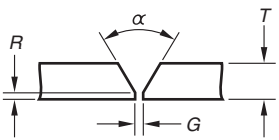
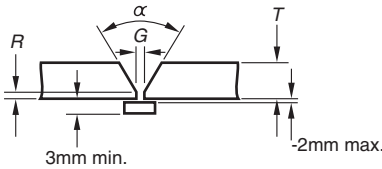
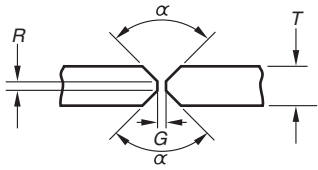
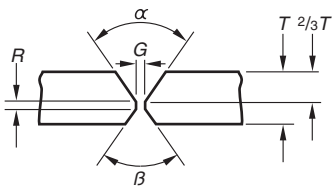
Weld type	Typical joint detail	Dimensions and remarks
<p>(a) Open square (without backing) Welded from both sides</p>		<p>Flat position: thickness T, 3 mm to 6 mm; gap G, 3 mm. Horizontal/vertical or vertical position: thickness T, 3 mm to 5 mm; gap G, 3 mm. See clause 11 for tolerances. See also clause 7.</p>
<p>(b) Open square (with backing) Welded from one side with backing which may be either temporary or permanent in which case it may be part of the structure or an integral part of one member</p>		<p>All positions. For flat position only *: Thickness T Gap G mm mm 3 to 5 6 5 to 8 8 8 to 16 10 If this preparation is used for material over 16 mm thick the gap may be required to be increased. See clause 11 for tolerances. See also clause 7.</p>
<p>(c) Single V (without backing) Welded from both sides or one side only</p>		<p>All positions. For flat positions only *: gap G, 2 mm; angle α, 60°; thickness T, 5 mm to 12 mm: root face R, 1 mm; thickness T, over 12 mm: root face R, 2 mm. See clause 11 for tolerances. See also clause 7.</p>
<p>(d) Single V (with backing) Welded from one side with backing which may be either temporary or permanent in which case it may be part of the structure or an integral part of one member</p>		<p>All positions: thickness T, over 10 mm. For flat position only *: root face R, 0; single root run: gap G, 6 mm; angle α, 45°; double root run: gap G, 10 mm; angle α, 20°. See clause 11 for tolerances. See also clause 7.</p>
<p>(e) Double V Welded from both sides</p>		<p>All positions: thickness T, over 12 mm. For flat position only *: gap G, 3 mm; angle α, 60°; root face R, 2 mm. See clause 11 for tolerances. See also clause 7.</p>
<p>(f) Asymmetric double V Welded from both sides</p>		<p>All positions: thickness T, over 12 mm. For flat position only *: gap G, 3 mm; angle α, 60°; angle β, 60°; root face R, 2 mm. See clause 11 for tolerances. See also clause 7. If the deeper V is welded first and full root penetration is required, the angle b may be increased to 90° to facilitate back gouging.</p>

* The dimensions of the weld preparation may have to be modified for other processes and for welding in positions other than flat.

Table 15 (concluded)

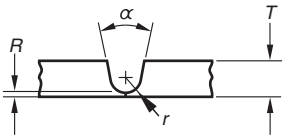
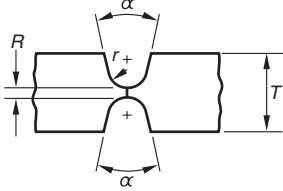
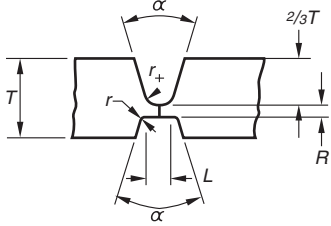
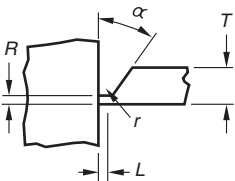
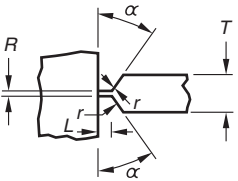
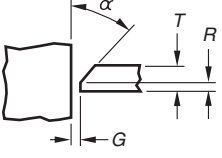
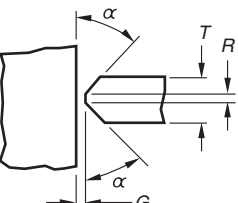
Weld type	Typical joint detail	Dimensions and remarks
(g) Single U Welded from both sides		<p>All positions: thickness T, over 20 mm.</p> <p>For flat position only *: angle α, 20°; radius r, 5 mm; root face R, 5 mm.</p> <p>See clause 11 for tolerances. See also clause 7.</p>
(h) Double U Welded from both sides		<p>All positions: thickness T, over 40 mm.</p> <p>For flat position only *: angle α, 20°; radius r, 5 mm; root face R, 5 mm.</p> <p>See clause 11 for tolerances. See also clause 7.</p>
(j) Asymmetric double U Welded from both sides		<p>All positions: thickness T, over 30 mm.</p> <p>For flat position only *: land L, 6 mm; angle α, 20°; radius r, 5 mm; root face R, 5 mm;</p> <p>See clause 11 for tolerances. See also clause 7.</p>
(k) Single J Welded from both sides		<p>All positions: thickness T, over 20 mm.</p> <p>For flat position only *: land L, 5 mm; angle α, 20°; radius r, 5 mm; root face R, 5 mm.</p> <p>See clause 11 for tolerances. See also clause 7.</p>
(l) Double J Welded from both sides		<p>All positions: thickness T, over 40 mm.</p> <p>For flat position only *: land L, 5 mm; angle α, 20°; radius r, 5 mm; root face R, 5 mm.</p> <p>See clause 11 for tolerances. See also clause 7.</p>
(m) Single bevel Welded from both sides		<p>All positions: For flat position only *: gap G, 3 mm; angle α, 45°; thickness T, 5 mm to 12 mm: root face R, 1 mm; thickness T, over 12 mm: root face R, 2 mm.</p> <p>See clause 11 for tolerances. See also clause 7.</p>
(n) Double bevel Welded from both sides		<p>All positions: thickness T, over 12 mm.</p> <p>For flat position only *: gap G, 3 mm; angle α, 45°; root face R, 2 mm.</p> <p>See clause 11 for tolerances. See also clause 7.</p>

* The dimensions of the weld preparation may have to be modified for other processes and for welding in positions other than flat.

ACKNOWLEDGEMENTS

Extracts—BSEN 1011. Permission is being sought from British Standards Institution.

[BLANK PAGE]