



PHYSICS

5054/31

Paper 3 Practical Test

May/June 2019

CONFIDENTIAL INSTRUCTIONS



This document gives details of how to prepare for and administer the practical exam.

The information in this document and the identity of any materials supplied by Cambridge International are confidential and must NOT reach candidates either directly or indirectly.

The supervisor must complete the report at the end of this document and return it with the scripts.

If you have any queries regarding these confidential instructions, contact Cambridge International stating the centre number, the syllabus and component number and the nature of the query.

email info@cambridgeinternational.org
phone +44 1223 553554
fax +44 1223 553558

This document consists of **15** printed pages and **1** blank page.

General information about practical exams

Centres must follow the guidance on science practical exams given in the *Cambridge Handbook*.

Safety

Supervisors must follow national and local regulations relating to safety and first aid.

Only those procedures described in the question paper should be attempted.

Supervisors must inform candidates that materials and apparatus used in the exam should be treated with caution. Suitable eye protection should be used where necessary.

Before the exam

- The packets containing the question papers must **not** be opened before the exam.
- It is assumed that standard school laboratory facilities, as indicated in the *Guide to Planning Practical Science*, will be available.
- Spare materials and apparatus for the tasks set must be available for candidates, if required.

During the exam

- It must be made clear to candidates at the start of the exam that they may request spare materials and apparatus for the tasks set.
- Where specified, the supervisor **must** perform the experiments and record the results as instructed. This must be done **out of sight** of the candidates, using the same materials and apparatus as the candidates.
- Any assistance provided to candidates must be recorded in the supervisor's report.
- If any materials or apparatus need to be replaced, for example, in the event of breakage or loss, this must be recorded in the supervisor's report.

After the exam

- The supervisor must complete a report for each practical session held and each laboratory used.
- Each packet of scripts returned to Cambridge International must contain the following items:
 - the scripts of the candidates specified on the bar code label provided
 - the supervisor's results relevant to these candidates
 - the supervisor's reports relevant to these candidates
 - seating plans for each practical session, referring to each candidate by candidate number
 - the attendance register.

Specific information for this practical exam

Number of sets of apparatus

In addition to a few spare sets, the minimum number of sets of apparatus to be provided should be sufficient to enable candidates to spend 20 minutes with the apparatus for each of Questions 1, 2 and 3, and one hour with the apparatus for Question 4. The order in which candidates answer the questions will be determined by the supervisor. Candidates may spend one hour circulating around Questions 1, 2 and 3, followed by an hour on Question 4, or vice versa.

It is assumed that candidates will supply their own calculator and geometrical instruments, such as a set square, 0° to 180° protractor, pair of compasses and 30 cm ruler. Candidates should be advised in advance that they may, if they wish, use wristwatches with stopwatch facilities, providing that such wristwatches afford the required precision.

Apparatus for Question 1

Items to be supplied by the centre (per set of apparatus, unless otherwise specified):

- length of thread (see note 1)
- split cork
- 300 g mass to act as a pendulum (see note 1)
- one expendable steel spring with a spring constant of approximately 25 N/m e.g. Philip Harris product code B8G87194 (see note 1)
- two bosses and a clamp (see note 1)
- stand (see note 2)
- stopwatch reading to 0.1 s or better
- metre rule with mm divisions
- a G-clamp or heavy weight to prevent the stand toppling.

Notes

1. The pendulum should be set up for the candidates as shown in Fig. 1.1. The end of the thread should be held in a split cork and held vertically in the clamp. The centre of the split cork should be approximately 20 cm from the centre of the stand. The thread and mass should be attached together to make a pendulum of length 100 cm from the bottom of the split cork to the bottom of the mass. The thread should be passed through one end loop of the spring.

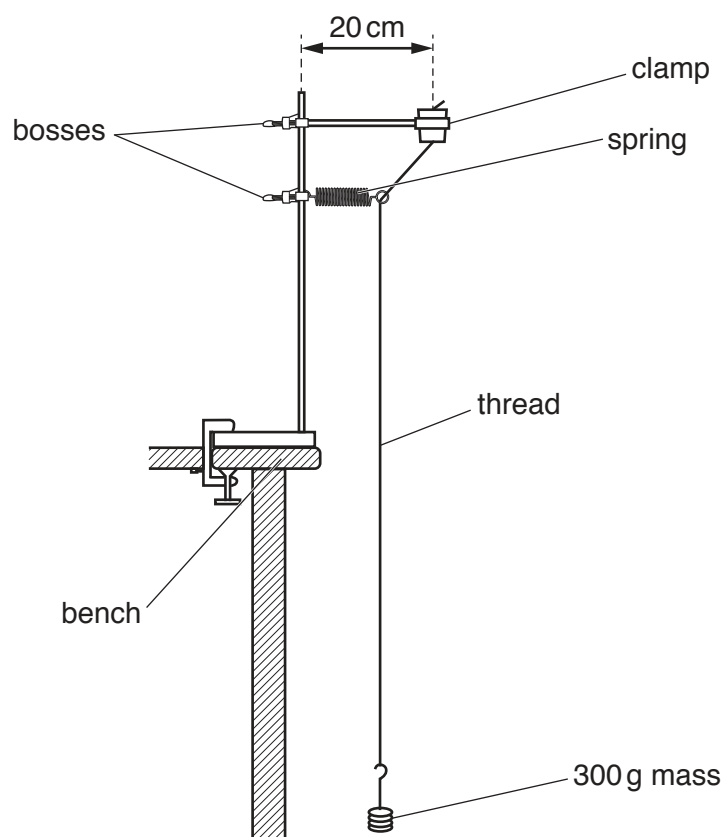

Fig. 1.1

A second boss should be attached to the stand approximately 10 cm below the boss holding the clamp. The other loop of the spring should be attached to the second boss as shown in Fig. 1.2.

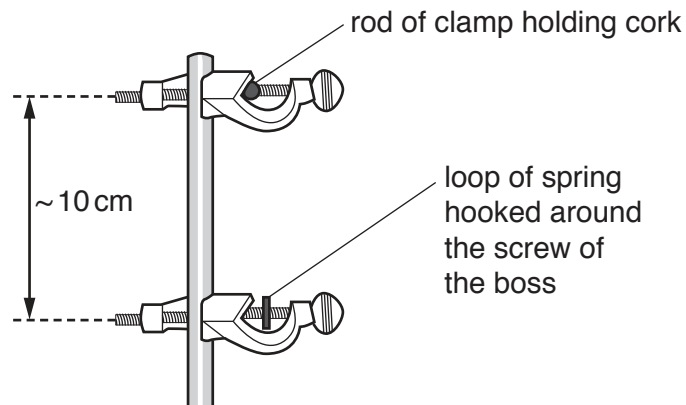

Fig. 1.2

2. The rod of the stand should be at least 60 cm in length to allow candidates to change the distance between the two bosses.

Information required by Examiners

Sample set of numerical results, clearly marked “supervisor’s results”, obtained out of sight of the candidates.

Apparatus for Question 2

Items to be supplied by the centre (per set of apparatus, unless otherwise specified):

- d.c. power supply in the range 4 V to 5 V (see note 1)
- fixed resistor of resistance 470 k Ω , labelled R₁
- fixed resistor of resistance 47 k Ω , labelled R₂
- 100 μ F capacitor labelled C (see note 2)
- stopwatch reading to 0.1 s or better
- switch or plug key
- digital voltmeter capable of measuring a potential difference of up to 5.0 V to a precision of 0.1 V or better (see note 3)
- connecting leads to enable the supervisor to set up the circuit shown in Fig. 2.1.

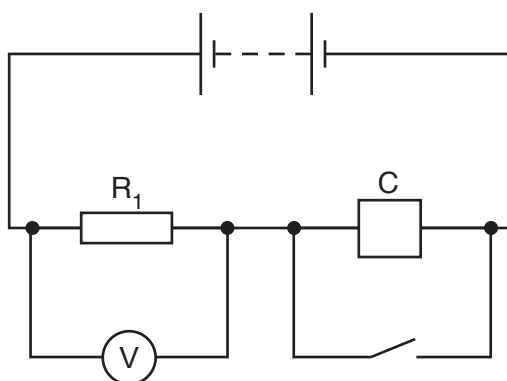

Fig. 2.1

Notes

1. The following are suitable power sources but all the candidates at a centre must be supplied with the same type of source:
 - three 1.5 V dry cells in suitable holders connected in series
 - four 1.2 V rechargeable cells in suitable holders connected in series
 - d.c. power supply of 4.5 V.

If a variable power supply is used, the supervisor must ensure that candidates cannot alter the output voltage.

- An electrolytic capacitor of nominal value $100\mu\text{F}$ e.g. RS component number 739-6799 should be labelled C. The circuit could be hazardous if the capacitor is connected the wrong way round. The supervisor must connect the positive terminal of the capacitor to the positive terminal of the power supply. Fig. 2.2 shows the negative and positive terminals of the two most common types of capacitor.

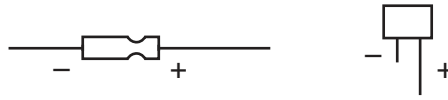

Fig. 2.2

- A digital multimeter is suitable. The supervisor must ensure that the meter is set to the 0 – 20V range. The range switch and other unused terminals must be taped over to prevent candidates changing the circuit.

At the changeover the supervisor must ensure that the apparatus is restored to the arrangement shown in Fig. 2.1.

Information required by Examiners

Sample set of numerical results, clearly marked “supervisor’s results”, obtained out of sight of the candidates.

Apparatus for Question 3

Items to be supplied by the centre (per set of apparatus, unless otherwise specified):

- L-shaped beam (see note 1)
- rod to act as a pivot (see note 2)
- stand, clamp and two bosses
- one 200g mass e.g. a 100g mass holder and 100g mass
- protractor (see note 3)
- metre rule (see note 3)
- small piece of wood (see note 3)
- wire hook (see note 4)
- set square.

Notes

1. The L-shaped beam should be made by joining together two pieces of wood (20.0 cm x 4.0 cm x 1.0 cm) as shown in Fig. 3.1. Wood glue is a suitable adhesive.

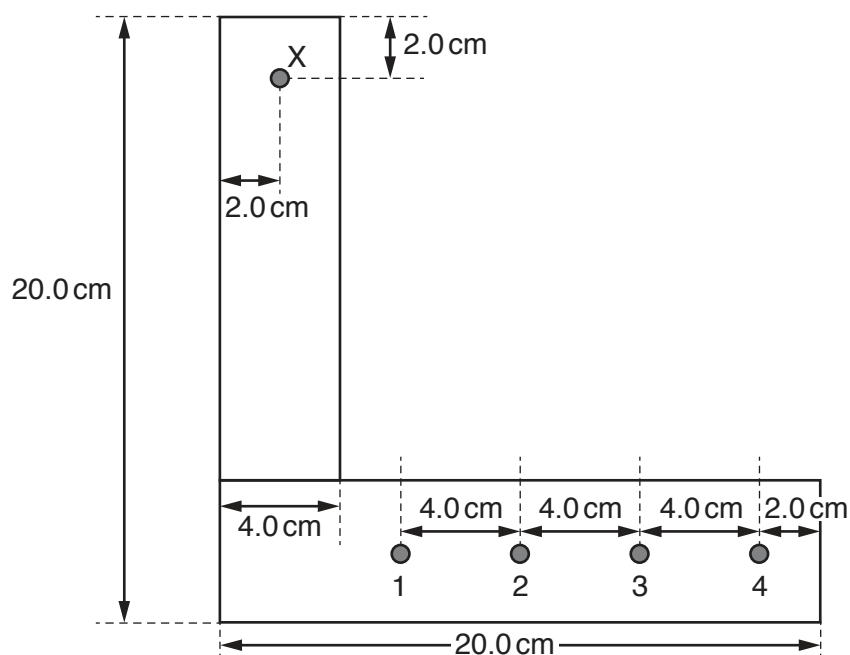

Fig. 3.1 (not to scale)

Four 5 mm diameter holes should be drilled along the centre of one arm of the beam starting at 2.0 cm from the right hand vertical end of the wood and then every 4.0 cm. These holes should be labelled 1 to 4 as shown in Fig. 3.1.

One 7 mm diameter hole should be drilled in the other arm of the beam at 2.0 cm below the top end and in the middle. This hole should be labelled X. It must be slightly bigger than the rod so that the rod can pass through and act as a pivot.

A small amount ('dab') of lubricant such as petroleum jelly (e.g. Vaseline®) should be inserted into each hole. All rough edges should be smoothed using abrasive paper e.g. sandpaper or emery paper or drill from both sides.

- The supervisor should set up the apparatus as shown in Fig. 3.2.

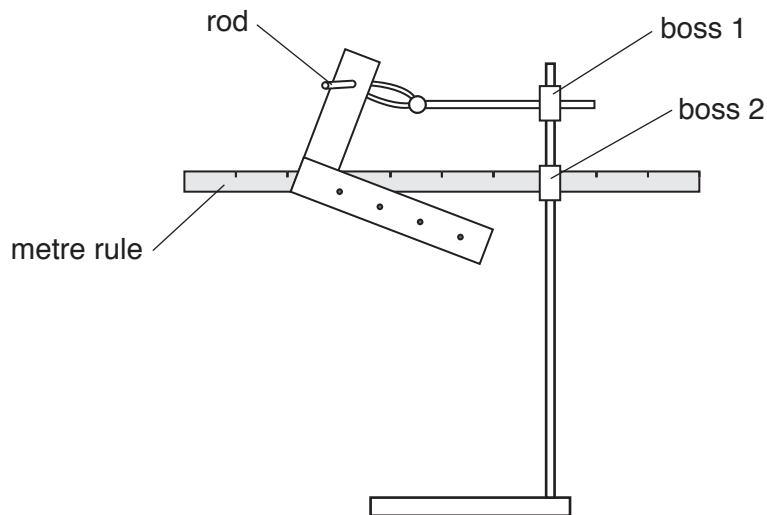

Fig. 3.2

The rod will act as a pivot so it must be rigid and have a smooth surface. The rod should be able to pass easily through the hole labelled X. A suitable rod is either a drill bit or a long steel nail (approx. 15 cm).

- The supervisor will use boss 2 to attach the rule to the stand so that the rule is horizontal.

To protect the surface of the ruler and to ensure that the plane of the flat face of the metre rule is vertical in the boss, a small piece of wood should be placed between the screw of the boss and the ruler as shown in Fig. 3.3.

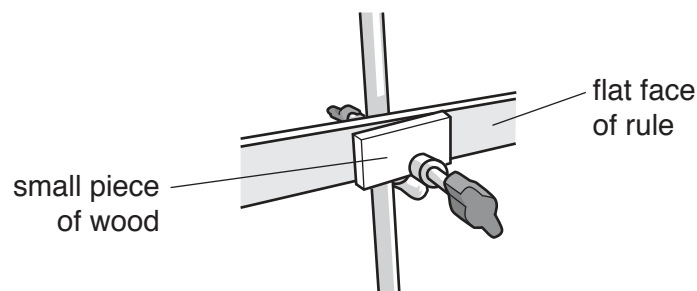

Fig. 3.3

It must be possible for candidates to measure the angle θ shown in Fig. 3.4

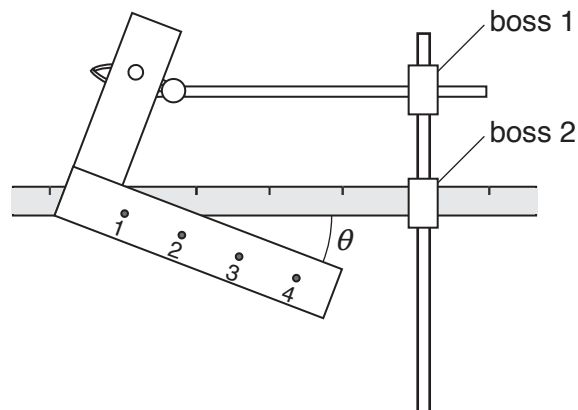

Fig. 3.4

4. Candidates will use the wire hook to suspend the 200 g mass from the L-shaped beam. A suitable hook may be made using a large steel paper clip, as shown in Fig. 3.5. It must be possible to suspend a 200 g mass from one end of the wire hook.

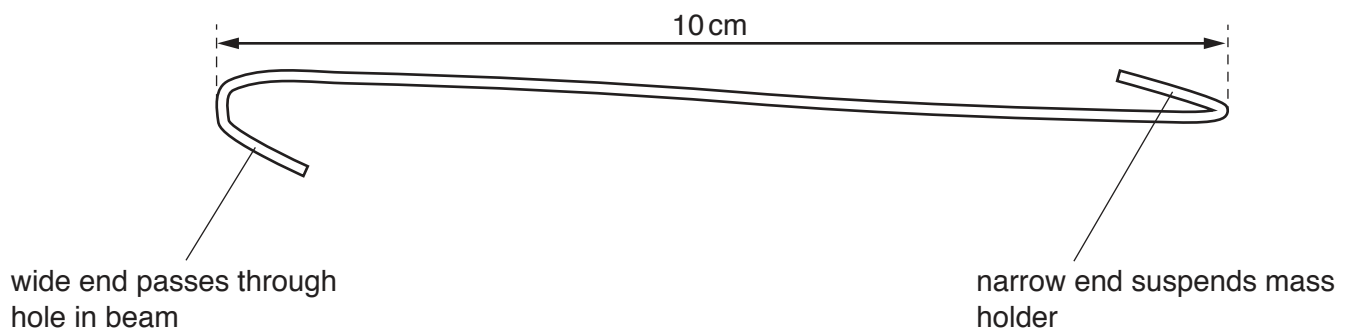

Fig. 3.5

At the changeover the supervisor must ensure that the apparatus is restored to the arrangement shown in Fig. 3.2. The metre rule should be horizontal by eye.

Information required by Examiners

Sample set of numerical results, clearly marked "supervisor's results", obtained out of sight of the candidates.

Apparatus for Question 4

Items to be supplied by the centre (per set of apparatus, unless otherwise specified):

- lamp (see note 1)
- 3V d.c. power source (see note 2)
- switch or plug key
- connecting leads
- slit plate attached to a rod (see note 3)
- 30 cm ruler with mm divisions
- stand, clamp and two bosses
- sheet of paper
- small pieces of Blu Tack
- metre rule with mm divisions. The zero on the scale must coincide with the end of the ruler.

Notes

1. Small torch lamp of approximate diameter 1 cm, 2.5V, 250 mA, filament indicator lamp, clear, e.g. RS 106-313. It must be placed in a small holder e.g. RS 171-2603 so that it can be gripped by the clamp. The clamp should be fastened to the stand so that the bottom of the lamp is 20 cm above the paper, as shown in Fig. 4.1. Spare lamps must be available. The lamp must be connected to the power source in series with the switch.

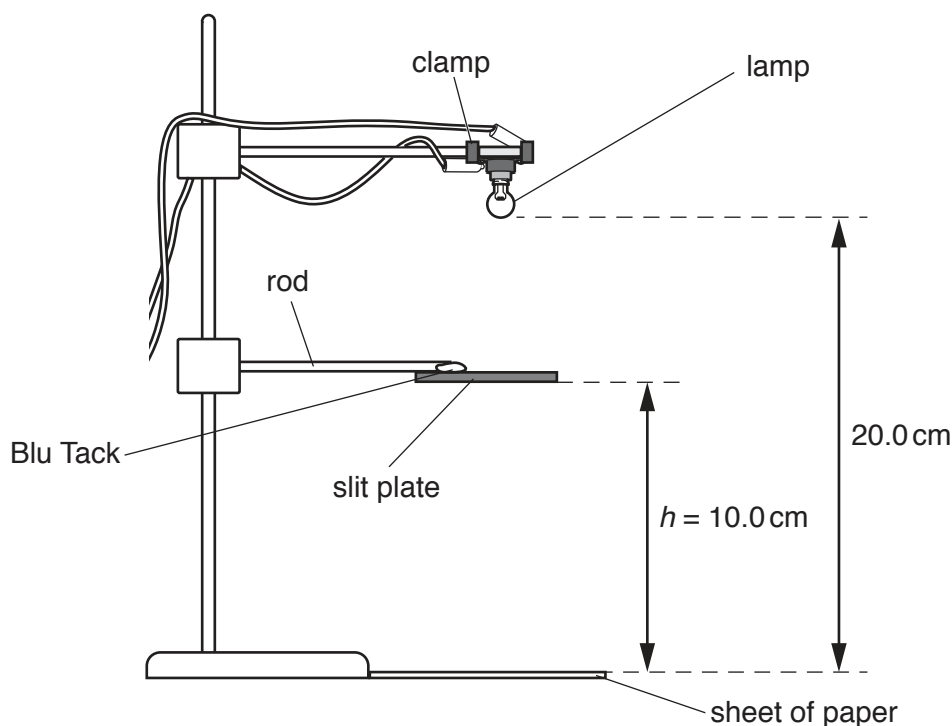

Fig. 4.1

The supervisor should place a small piece of Blu Tack under each corner of the sheet of paper and press down to ensure that the paper remains in place during the experiment. Candidates will be taking measurements from an image on the paper so the experiment must be performed in a darkened part of the laboratory or classroom.

2. A power source is required to operate the lamp at its normal voltage. The following are suitable power sources but all the candidates at a centre must be supplied with the same type of source:
 - two 1.5V dry cells in suitable holders connected in series
 - three 1.2V rechargeable cells in suitable holders connected in series
 - d.c. power supply of 3V

3. A slit plate may be found in a ray box kit if one is available, but it must have the dimensions shown in Fig. 4.2. Alternatively, the plate should be cut from a piece of rigid card into a rectangle of length 80 mm and width 50 mm. Slits of width 1.0 mm and length 27 mm should be cut into the card 17 mm apart, as shown in Fig. 4.2.

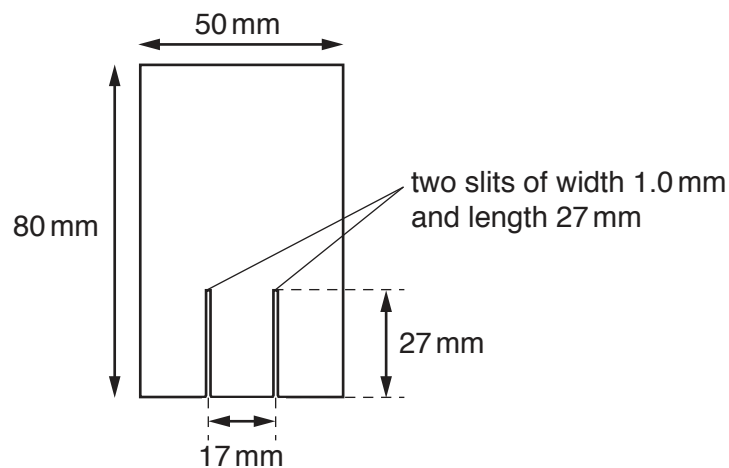

Fig. 4.2

A piece of Blu Tack should be attached to the slit plate. The end of a rod of approximate length 200 mm and diameter 5 mm should be pressed firmly into the Blu Tack as shown in Fig. 4.3.

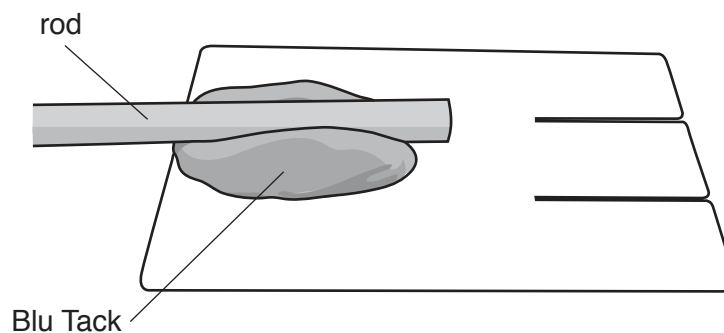

Fig. 4.3

Clamp the rod to the stand approximately 10 cm above the paper.

At the changeover the supervisor must ensure that the apparatus is returned to the arrangement shown in Fig. 4.1 and check that the lamp and cells (if cells have been used) are still operational. The sheet of paper should also be replaced if the candidate has made notes or marks on it.

Information required by Examiners

Sample set of numerical results, clearly marked “supervisor’s results”, obtained out of sight of the candidates.

BLANK PAGE

Permission to reproduce items where third-party owned material protected by copyright is included has been sought and cleared where possible. Every reasonable effort has been made by the publisher (UCLES) to trace copyright holders, but if any items requiring clearance have unwittingly been included, the publisher will be pleased to make amends at the earliest possible opportunity.

To avoid the issue of disclosure of answer-related information to candidates, all copyright acknowledgements are reproduced online in the Cambridge Assessment International Education Copyright Acknowledgements Booklet. This is produced for each series of examinations and is freely available to download at www.cambridgeinternational.org after the live examination series.

Cambridge Assessment International Education is part of the Cambridge Assessment Group. Cambridge Assessment is the brand name of the University of Cambridge Local Examinations Syndicate (UCLES), which itself is a department of the University of Cambridge.

Supervisor's report

Syllabus and component number

				/		
--	--	--	--	---	--	--

Centre number

--	--	--	--	--

Centre name

Time of the practical session

Laboratory name/number

Give details of any difficulties experienced by the centre or by candidates (include the relevant candidate names and candidate numbers).

You must include:

- any difficulties experienced by the centre in the preparation of materials
- any difficulties experienced by candidates, e.g. due to faulty materials or apparatus
- any specific assistance given to candidates.

Declaration

- 1 Each packet that I am returning to Cambridge International contains the following items:
 - the scripts of the candidates specified on the bar code label provided
 - the supervisor's results relevant to these candidates
 - the supervisor's reports relevant to these candidates
 - seating plans for each practical session, referring to each candidate by candidate number
 - the attendance register
- 2 Where the practical exam has taken place in more than one practical session, I have clearly labelled the supervisor's results, supervisor's reports and seating plans with the time and laboratory name/number for each practical session.
- 3 I have included details of difficulties relating to each practical session experienced by the centre or by candidates.
- 4 I have reported any other adverse circumstances affecting candidates, e.g. illness, bereavement or temporary injury, directly to Cambridge International on a *special consideration form*.

Signed (supervisor)

Name (in block capitals)