



Cambridge IGCSE™

CANDIDATE
NAME

CENTER
NUMBER

--	--	--	--	--

CANDIDATE
NUMBER

--	--	--	--



MATHEMATICS (US)

0444/13

Paper 1 (Core)

October/November 2020

1 hour

You must answer on the question paper.

You will need: Geometrical instruments

INSTRUCTIONS

- Answer **all** questions.
- Use a black or dark blue pen. You may use an HB pencil for any diagrams or graphs.
- Write your name, center number and candidate number in the boxes at the top of the page.
- Write your answer to each question in the space provided.
- Do **not** use an erasable pen or correction fluid.
- Do **not** write on any bar codes.
- Calculators must **not** be used in this paper.
- You may use tracing paper.
- You must show all necessary work clearly.
- All answers should be given in their simplest form.

INFORMATION

- The total mark for this paper is 56.
- The number of marks for each question or part question is shown in parentheses [].

This document has **12** pages. Blank pages are indicated.

Formula List

Area, A , of triangle, base b , height h .

$$A = \frac{1}{2}bh$$

Area, A , of circle, radius r .

$$A = \pi r^2$$

Circumference, C , of circle, radius r .

$$C = 2\pi r$$

Lateral surface area, A , of cylinder of radius r , height h .

$$A = 2\pi rh$$

Surface area, A , of sphere of radius r .

$$A = 4\pi r^2$$

Volume, V , of prism, cross-sectional area A , length l .

$$V = Al$$

Volume, V , of cylinder of radius r , height h .

$$V = \pi r^2 h$$

Volume, V , of sphere of radius r .

$$V = \frac{4}{3}\pi r^3$$

1 This bar chart shows the amount of rainfall, in mm, for each month of one year in a city.

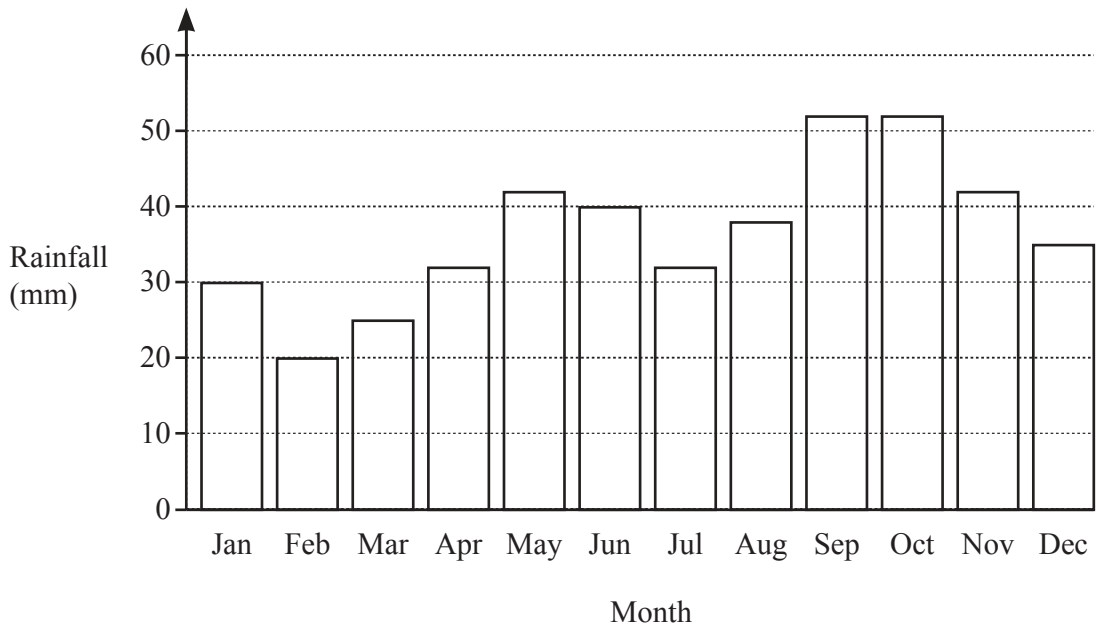

(a) Write down the month with the least amount of rainfall.

..... [1]

(b) This bar chart shows the number of days it rained each month for the same year in this city.

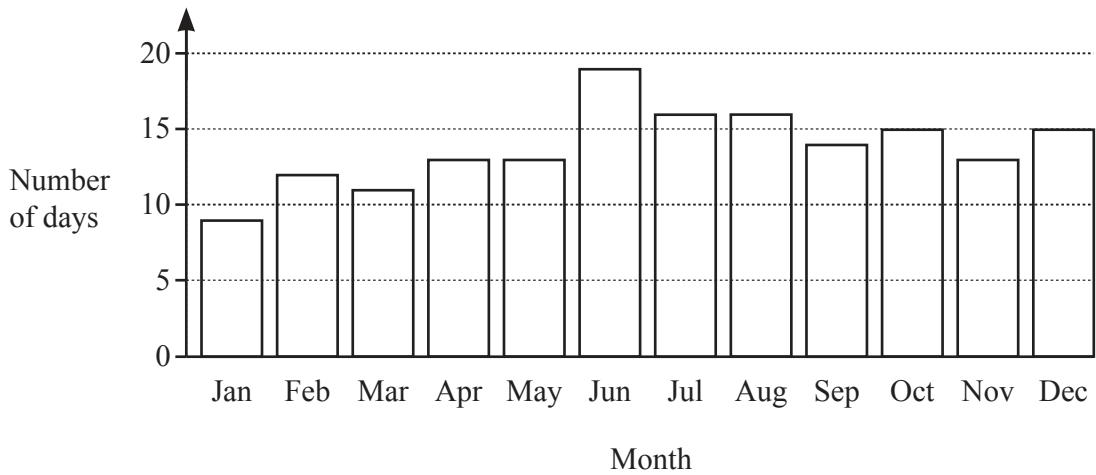

Mia says that the months with the most rainfall also have the greatest number of days it rained.

Explain why she is wrong.

.....
 [1]

2 Complete this bill.

2 kg potatoes at \$2.52 per kg	\$
..... kg bananas at \$1.50 per kg	\$
Total =	\$ 11.04

[3]

3 (a) Write 97.4236 correct to 3 decimal places.

..... [1]

(b) Find $\sqrt[3]{-8}$.

..... [1]

4 Write down the order of rotational symmetry of each shape.

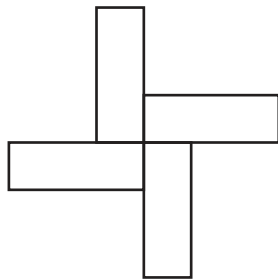

.....

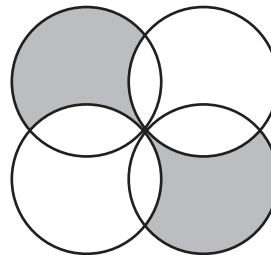

.....

[2]

5 The mean of five numbers is 16.

Four of these numbers are 12, 20, 19, and 11.

Find the fifth number.

..... [2]

6 In triangle ABC , $BC = 7.6$ cm and $AC = 6.2$ cm.

Using a compass and ruler only, construct triangle ABC .

Leave in your construction arcs.

The side AB has been drawn for you.



[2]

- 7 (a) This table shows the temperature, in $^{\circ}\text{C}$, at midnight and at 3 pm for four cities on the same day.

City	Temperature at midnight ($^{\circ}\text{C}$)	Temperature at 3 pm ($^{\circ}\text{C}$)
Sydney	21	28
Oslo	-3	1
Toronto	-18	-8
Seoul	-5	4

Use the table to complete this statement.

The city with the biggest difference in temperature between midnight and 3 pm

is with a difference of $^{\circ}\text{C}$. [2]

- (b) The temperature at midnight in Moscow was -11°C .
At 3 pm the temperature has increased by 5°C .

Work out the temperature at 3 pm.

..... $^{\circ}\text{C}$ [1]

- 8 Megan changes 20 pounds (£) into dollars when the exchange rate is $\text{£}1 = \$1.20$.

Work out how many dollars she receives.

\$ [1]

- 9 $f(x) = 4x + 3$

Find the value of $f(0)$.

..... [1]

- 10 Ethan invests \$6400 at a rate of 2% per year simple interest.

Work out the total value of his investment at the end of 3 years.

\$ [3]

- 11 A straight line, l , has equation $y = 5x + 12$.

(a) Write down the slope of line l .

..... [1]

(b) Find the coordinates of the point where line l crosses the x -axis.

(.....,) [2]

- 12 $g(x) = 8x$

(a) Solve $g(x) = 5$.

$x =$ [1]

(b) Solve $g(x) + 2 = 10x$.

$x =$ [2]

- 13 A gift box has length 25 cm, width 20 cm, and height 10 cm.

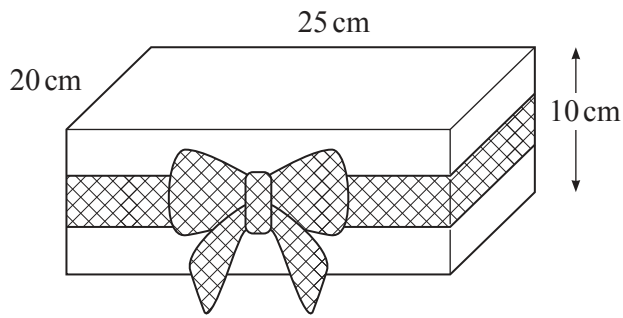

NOT TO
SCALE

- (a) Leanne wraps a piece of ribbon around the sides of the gift box and ties it into a bow. The piece of ribbon is 1.22 meters long.

How many centimeters of ribbon does Leanne use to make the bow?

..... cm [3]

- (b) Find the volume of the gift box.

..... cm³ [2]

14

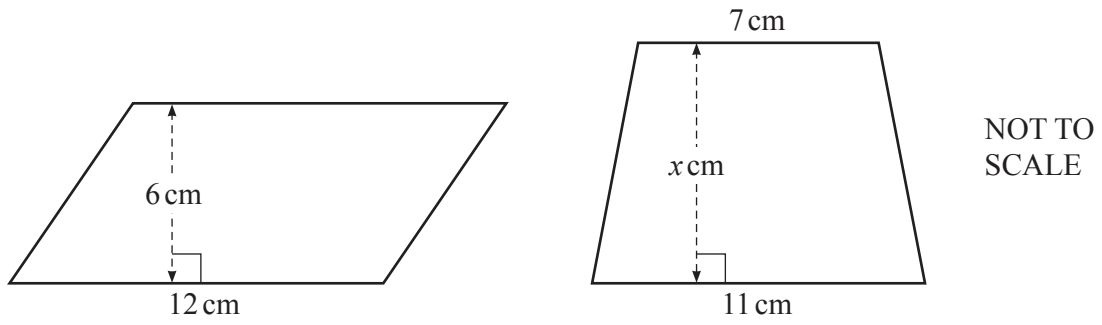

The area of the parallelogram is the same as the area of the trapezoid.

Work out the value of x .

$$x = \dots\dots\dots [3]$$

15 Share \$60 in the ratio 7 : 5.

$$\$ \dots\dots\dots, \$ \dots\dots\dots [2]$$

- 16 By writing each number correct to 1 significant figure, estimate the value of

$$\frac{3.4 \times 13.2}{7.5 - 2.1}$$

You must show all your working.

..... [2]

- 17 A bag contains 7 red disks, 5 green disks, and 2 pink disks.

Helen takes one disk at random, records the color, and replaces it in the bag.
She does this 140 times.

Find how many times she expects to take a green disk.

..... [2]

- 18 Expand and simplify.

$$4(2m + 3) - 5(m - 2)$$

..... [2]

- 19 Ramond walks 800 meters in 10 minutes.

Work out Ramond's average speed in kilometers per hour.

..... km/h [3]

- 20 A regular polygon has an exterior angle of 20° .

Work out the number of sides of this polygon.

..... [1]

- 21 Work out $1\frac{1}{7} \times 2\frac{1}{10}$.

Give your answer as a mixed number in its simplest form.

..... [3]

Questions 22 and 23 are printed on the next page.

22

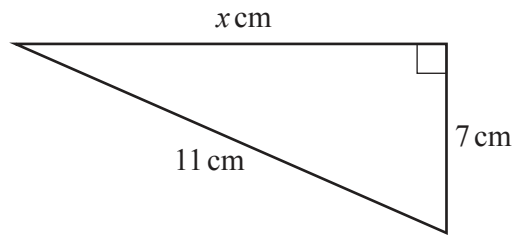
NOT TO
SCALE

Alisha says that the value of x must be between 8 and 9.

Show that Alisha is correct.

[3]

- 23 Solve the system of linear equations.
You must show all your working.

$$3x - 8y = 22$$

$$x + 4y = 4$$

$$x = \dots\dots\dots$$

$$y = \dots\dots\dots [3]$$

Permission to reproduce items where third-party owned material protected by copyright is included has been sought and cleared where possible. Every reasonable effort has been made by the publisher (UCLES) to trace copyright holders, but if any items requiring clearance have unwittingly been included, the publisher will be pleased to make amends at the earliest possible opportunity.

To avoid the issue of disclosure of answer-related information to candidates, all copyright acknowledgements are reproduced online in the Cambridge Assessment International Education Copyright Acknowledgements Booklet. This is produced for each series of examinations and is freely available to download at www.cambridgeinternational.org after the live examination series.

Cambridge Assessment International Education is part of the Cambridge Assessment Group. Cambridge Assessment is the brand name of the University of Cambridge Local Examinations Syndicate (UCLES), which itself is a department of the University of Cambridge.